

SKF TMMK 20-50

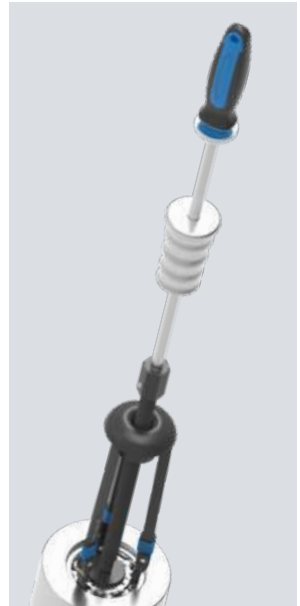

Instructions for use
Bedienungsanleitung
Instrucciones de uso
Mode d'emploi

Manuale d'istruzioni
Instruções de uso
Инструкция по эксплуатации
使用说明书

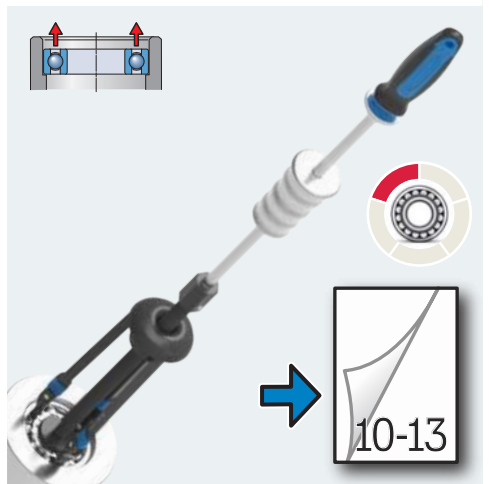
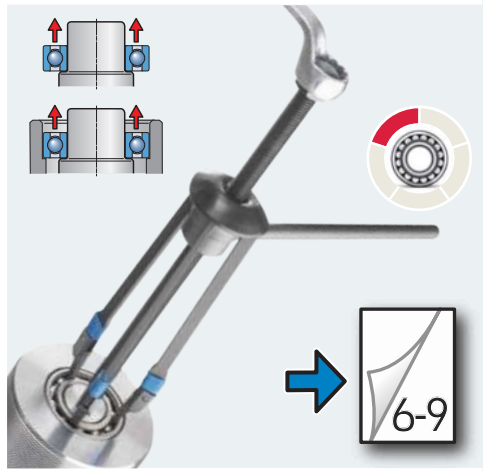
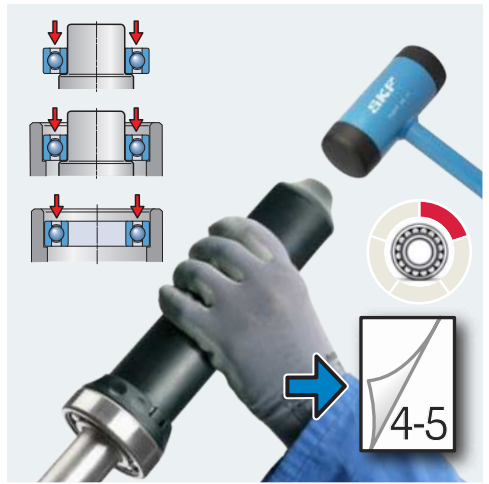
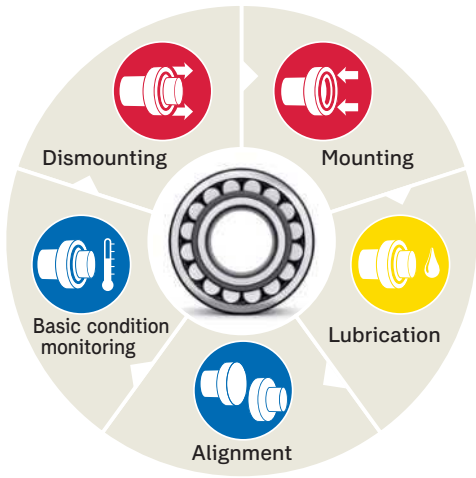

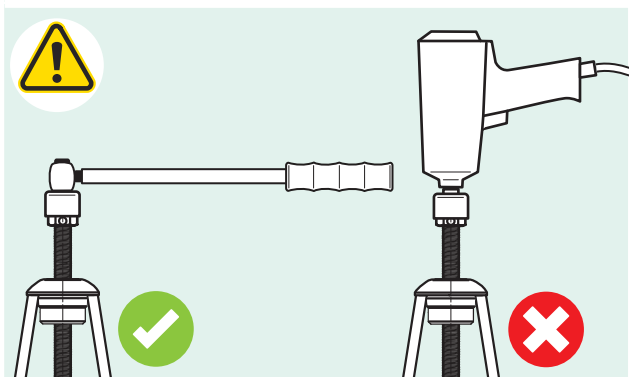
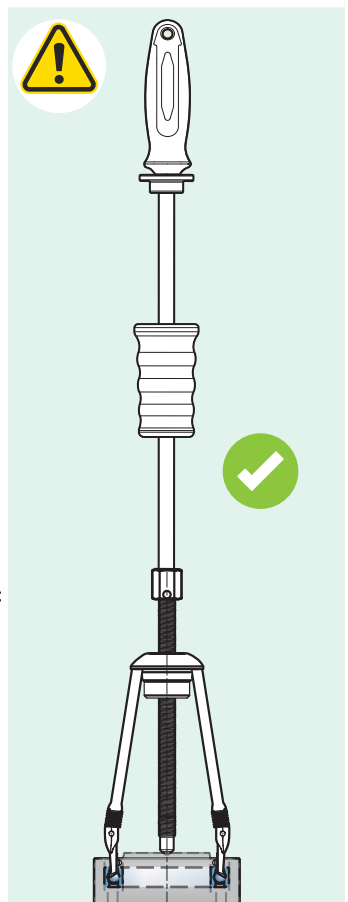
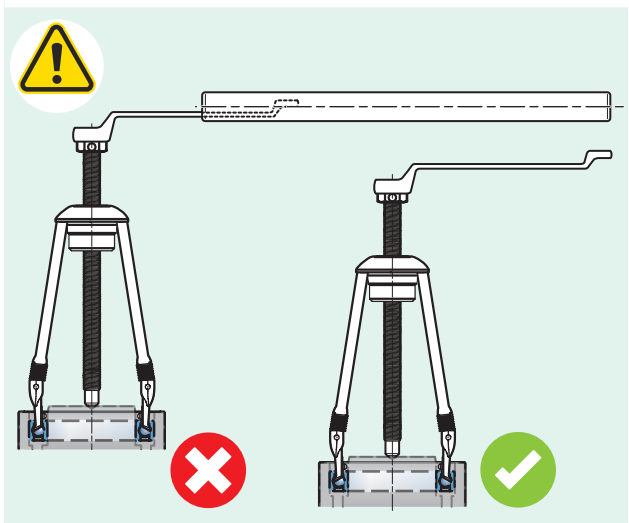
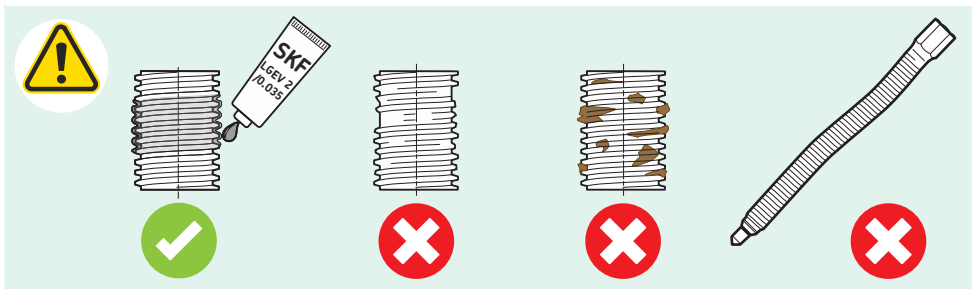
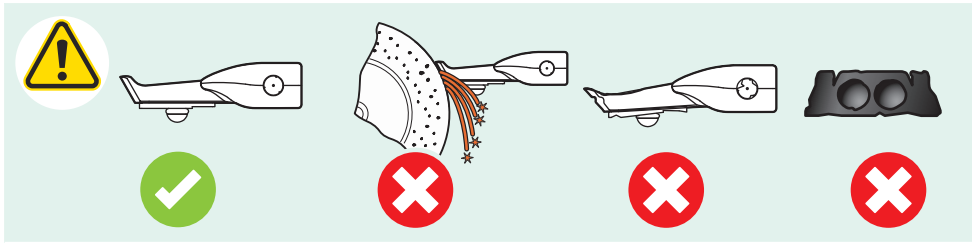

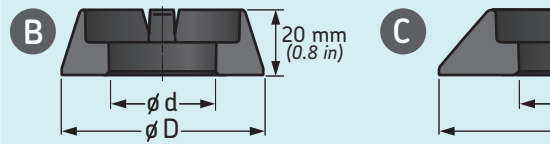
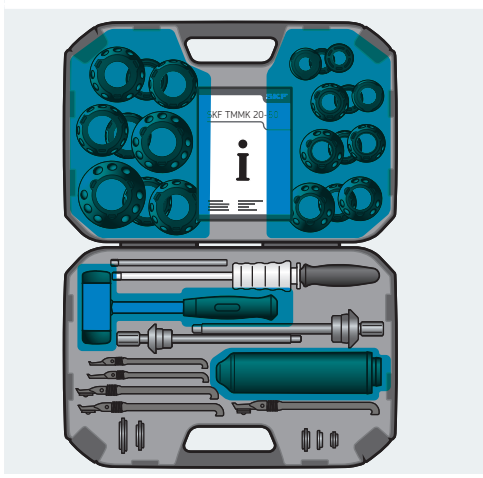
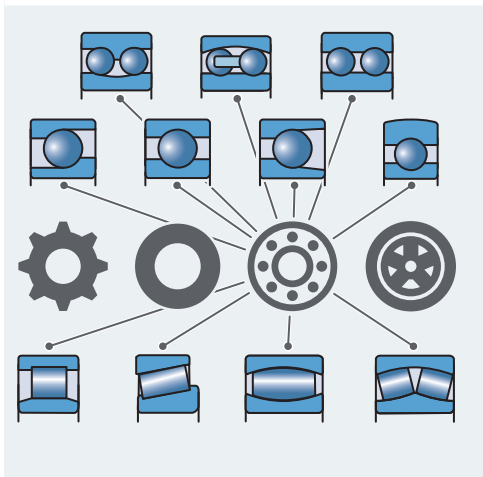
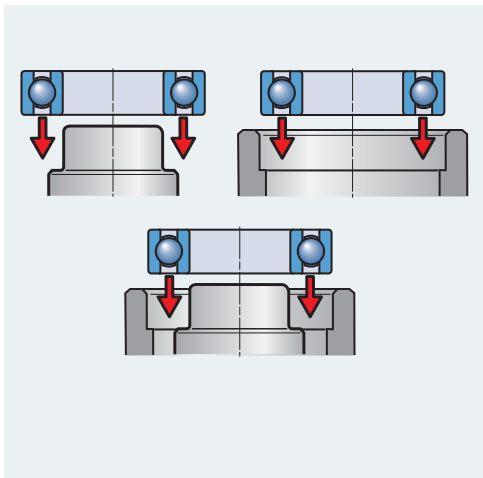

B	d		D	60..	6
	mm	in	mm in		
TMFT 36 B20-42	20	0.8	42 1.6	6004	
TMFT 36 B20-47	20	0.8	47 1.8		6
TMFT 36 B20-52	20	0.8	52 2.0		
TMFT 36 B25-47	25	1.0	47 1.9	6005	6
TMFT 36 B25-52	25	1.0	52 2.0		6
TMFT 36 B25-62	25	1.0	62 2.4		
TMFT 36 B30-55	30	1.2	55 2.2	6006	6
TMFT 36 B30-62	30	1.2	62 2.4		6
TMFT 36 B30-72	30	1.2	72 2.8		
TMFT 36 B35-62	35	1.4	62 2.4	6007	
TMFT 36 B35-72	35	1.4	72 2.8		6
TMFT 36 B35-80	35	1.4	80 3.1		

C	d		D	60..	6
	mm	in	mm in		
TMFT 36 C40-68	40	1.6	68 2.7	6008	
TMFT 36 C40-80	40	1.6	80 3.1		6
TMFT 36 C40-90	40	1.6	90 3.5		
TMFT 36 C45-75	45	1.8	75 2.9	6009	
TMFT 36 C45-85	45	1.8	85 3.3		6
TMFT 36 C45-100	45	1.8	100 3.9		
TMFT 36 C50-80	50	2.0	80 3.1	6010	
TMFT 36 C50-90	50	2.0	90 3.5		6
TMFT 36 C50-110	50	2.0	110 4.3		

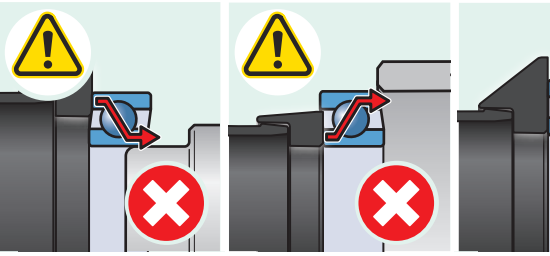

2.. 63.. 64.. 160..
16004
204
6304
2/22 16005
205 63/22
6305 6403
2/28 16006
206 63/28
6306 6404
16007
207
6307 6405
2.. 63.. 64.. 160..
16008
208
6308 6406
16009
209
6309 6407
16010
210
6310 6408

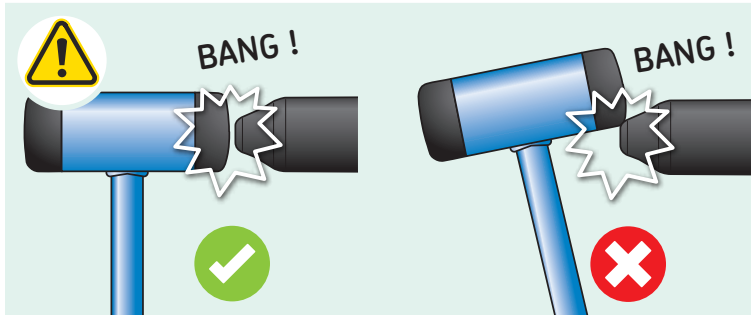

1 ? ? ?

d	D	60	62	63	64	160
mm in	mm in	mm in	mm in	mm in	mm in	mm in
TMFT 36 A10-26	10 0.4	26 1.0	6000			16100
TMFT 36 A10-30	10 0.4	30 1.2	6200			16100
TMFT 36 A10-35	10 0.4	35 1.4				16101
TMFT 36 A12-28	12 0.5	28 1.1	6001			16101
TMFT 36 A12-32	12 0.5	32 1.3	6203			16101
TMFT 36 A12-37	12 0.5	37 1.5				16101
TMFT 36 A15-30	15 0.6	32 1.3	6002			16101
TMFT 36 A15-35	15 0.6	35 1.4	6202			16101
TMFT 36 A15-42	15 0.6	42 1.7				16101
TMFT 36 A17-35	17 0.7	35 1.4	6003			16101
TMFT 36 A17-42	17 0.7	42 1.7	6201			16101
TMFT 36 A17-50	17 0.7	50 2.0				16101

? ? ?

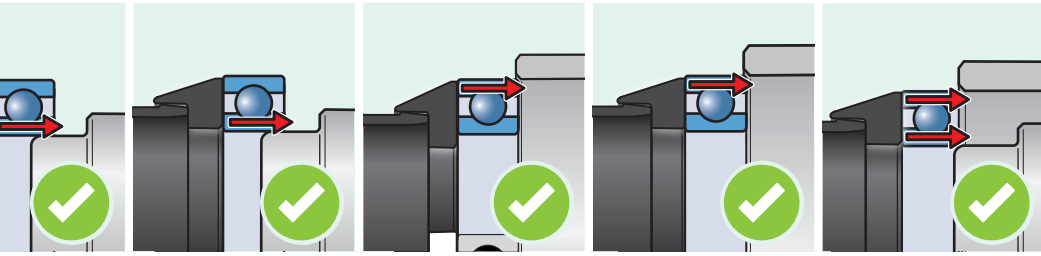
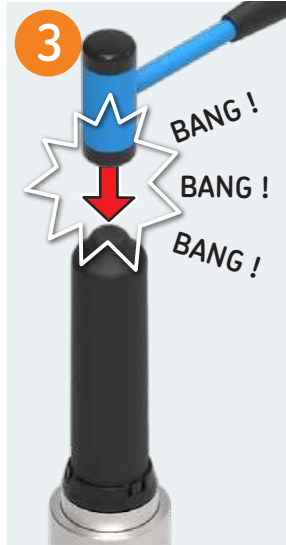

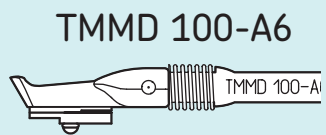
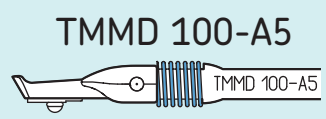
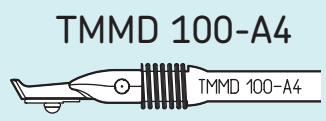
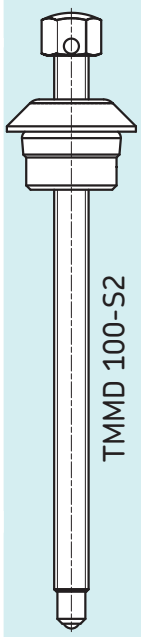
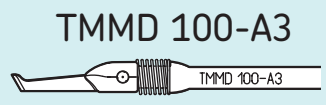
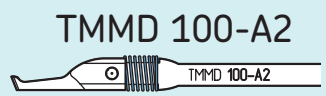
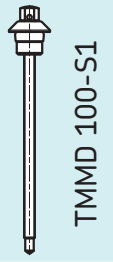
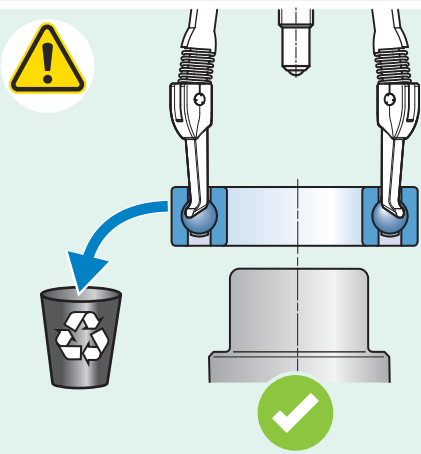
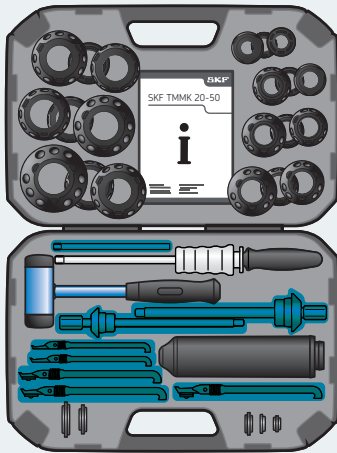
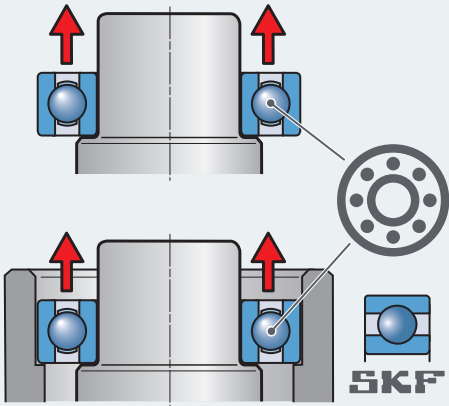



60..	62..	63..	64..	160..
------	------	------	------	-------

6004	6201			
6005	6202			
6006	6203			
6007	6204	6300		16011
6008	6205	6301		
6009	62/22	6302		
6010				



	6206	6303		
	62/28	6304		



6011		63/22		
6012				
6013				



	6207	6305		
	6208	63/28		



6014	6209	6306	6403	
6015				



6016	6210	6307		
6017	6211			



6018		6308	6404	
6019			6405	
6020				



	6212		6406	
	6213			



	6214	6309	6407	
	6215	6310		
	6216			
	6217			



	6218	6311	6408	
		6312	6409	



		6313	6410	
--	--	------	------	--

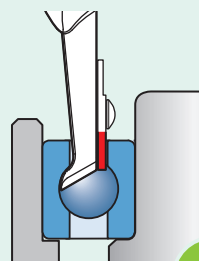
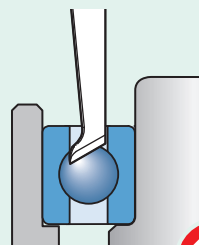
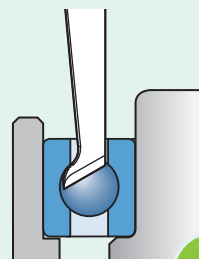
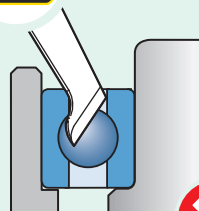

1 ? ? ?

	60.	62.	63.	64.	160.	161.
TMMD 100-A1	6000	6200	6300	6400	16000	16100
	6001				16001	16101
	6002					
	6003					
TMMD 100-A2	6004	6201				
	6005	6202				
	6006	6203				
TMMD 100-A3	6007	6204	6300			16011
	6008	6205	6301			
	6009	6222	6302			
	6010					
TMMD 100-A4		6206	6303			
		6228	6304			
	6011					
	6012					
	6013					
TMMD 100-A5		6207	6305			
		6208	6328			
		6209	6302			
		6210	6307			
	6018	6219	6307			
	6017	6211				
	6019		6308	6404		
	6020					
		6212				
		6213				
		6214	631			
		6215	631			
		6216	631			
		6217	631			
		6218	631			
		6219	631			
		6220	631			

6-7

2 A4 / A5 / A6

x3

6-7

3 I

5 II

~120°

6 II

7 III

9

10

11

4

I

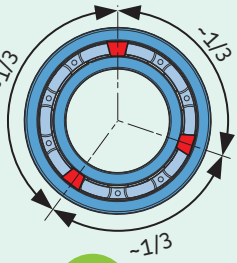
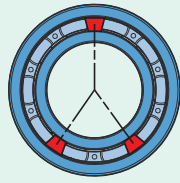
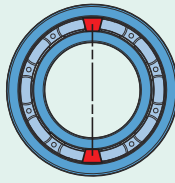
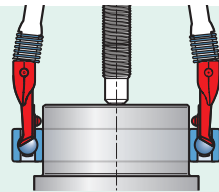

8



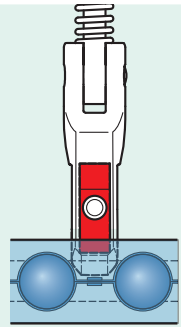
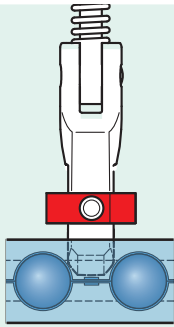
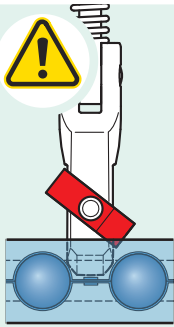



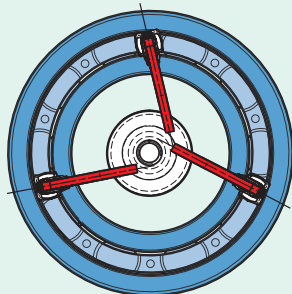
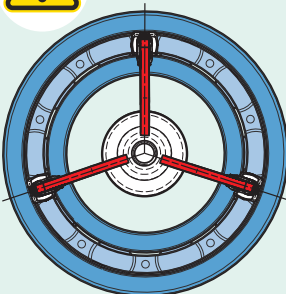

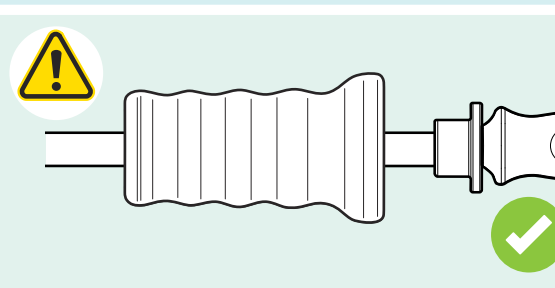
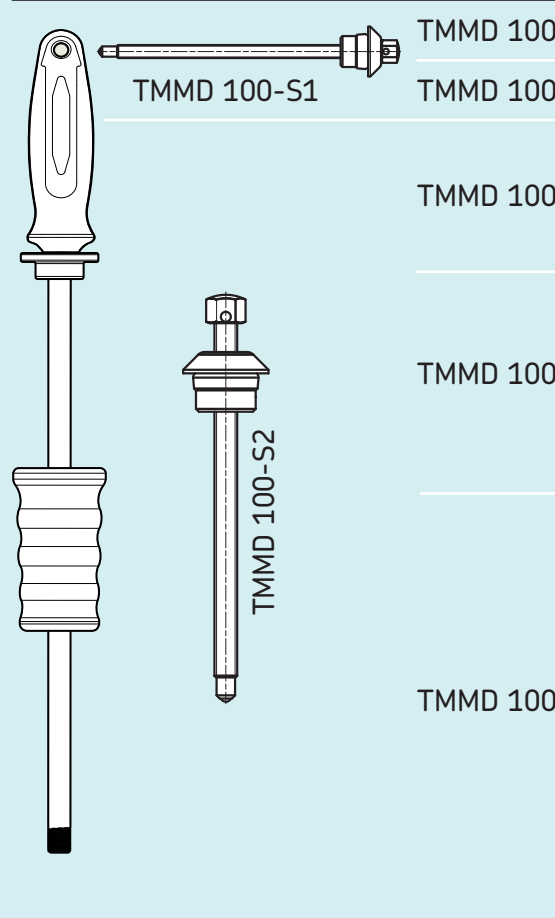
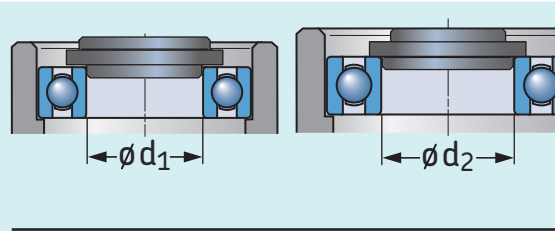
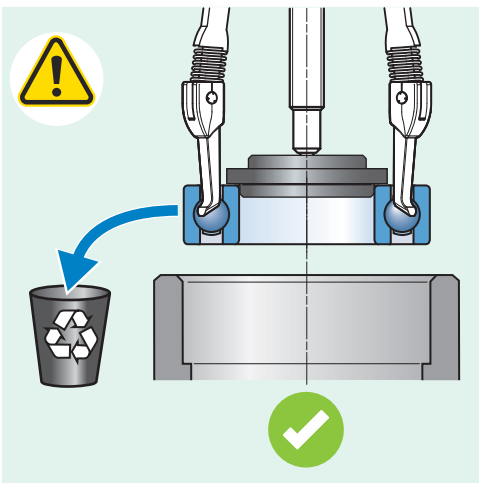
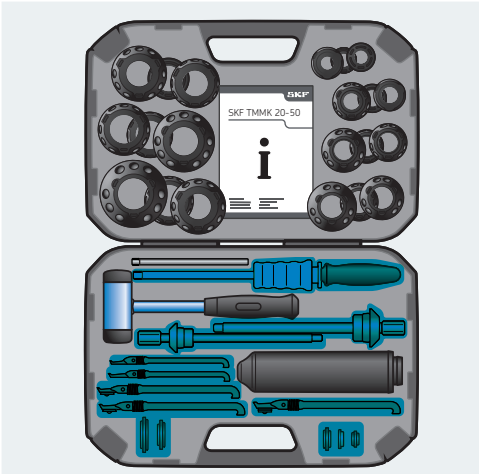
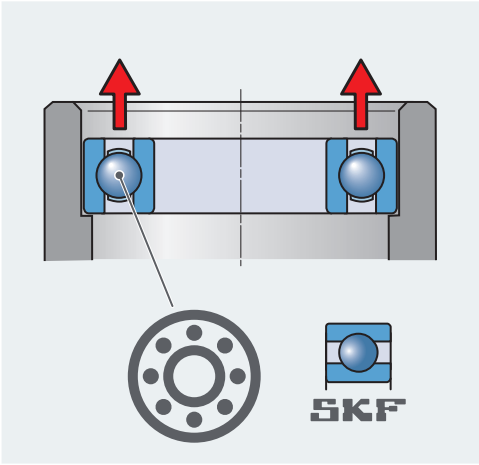
III



12

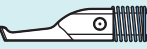

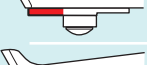
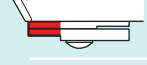

											
		d ₁	d ₂	d ₁	d ₁	d ₂	d ₁	d ₂	d ₁	d ₂	
	mm	20	22	25	28	30	35	40	45	50	
	in	0.8	0.9	1.0	1.1	1.2	1.4	1.6	1.8	2.0	
-A2		6004		6005		6006					
-A3		6204	62/22	6205				6007	6008	6009 6010	
-A4		6304				62/28	6206				
		63/22									
-A5				6305	63/28		6207 6208				
						6306		6209			
								6307	6210		
		6404	6405				6308				
-A6						6406					
								6407	6309 6310		
								6408	6409		
										6410	

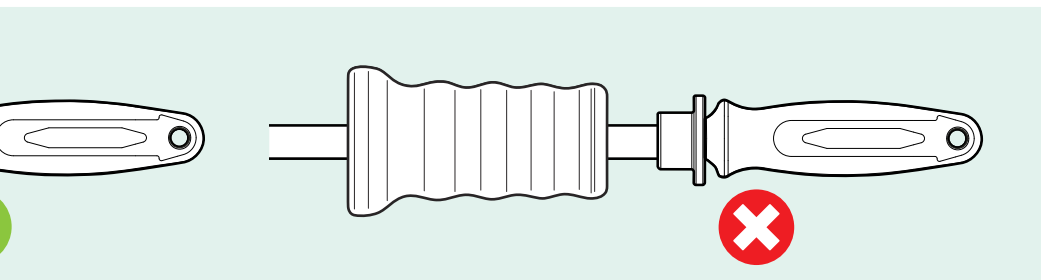

1

? ? ?

	d ₁	d ₂	d ₁	d ₂	d ₁	d ₂	d ₁	d ₂
mm	20	22	25	30	35	40	45	50
in	0.8	0.9	1.0	1.2	1.4	1.6	1.8	2.0
TMMD 100-A2	6004	6005	6006					
TMMD 100-S1								
TMMD 100-A3	6204	62/22	6205		6007	6008	6009	6010
TMMD 100-A4	6304		62/28	6306				
		63/22			6207	6208		
TMMD 100-A5	6305	63/28	6306					
TMMD 100-S2								
TMMD 100-A6	6404	6405			6307		6210	

2

A4/A5/A6

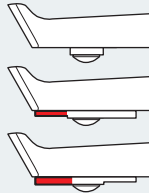

6

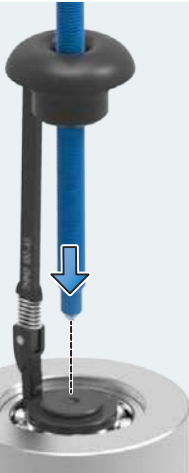

7

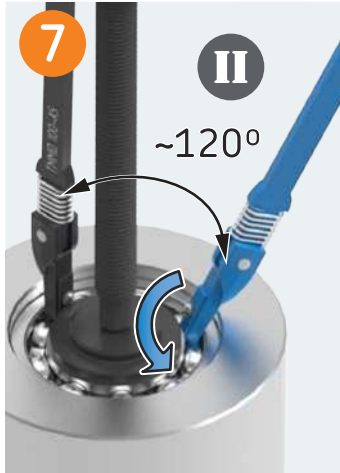

8

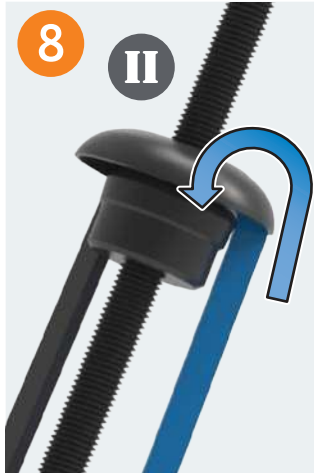

9



10



11



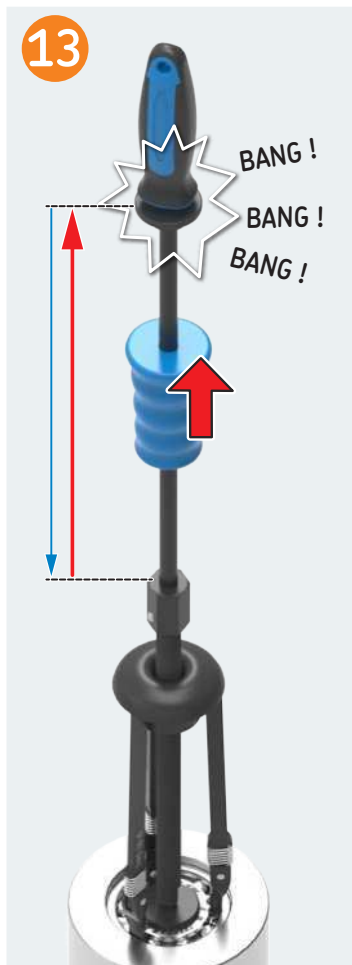
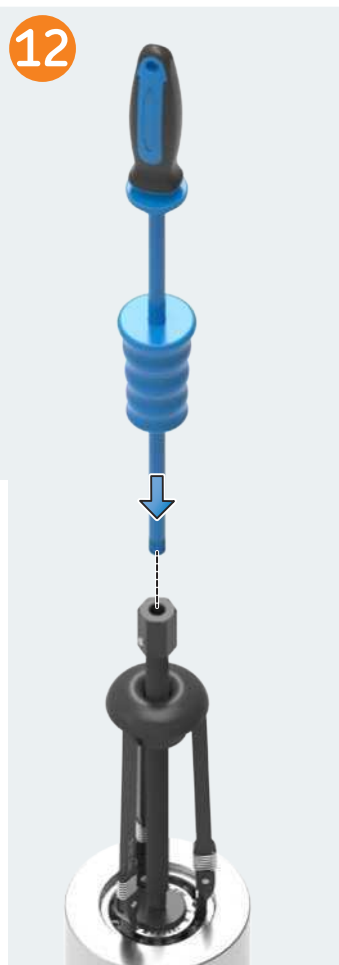
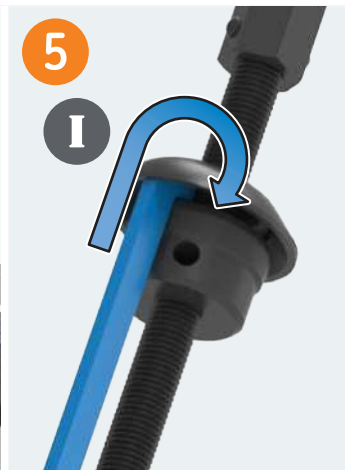

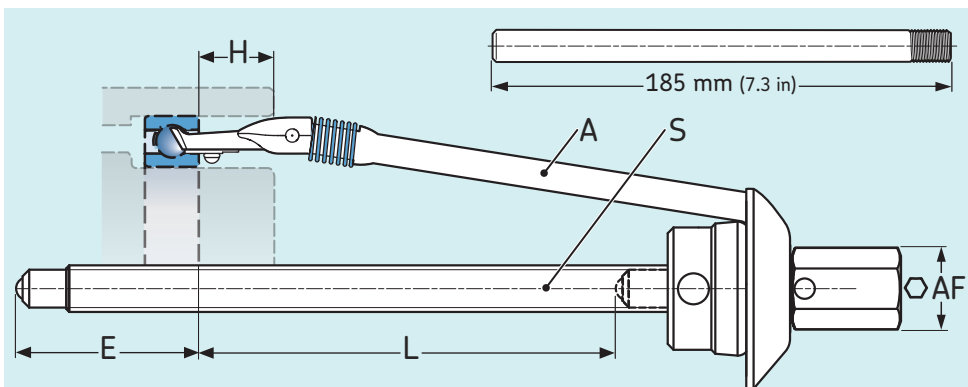

S	A	L		H		E		AF
		mm	in	mm	in	mm	in	
TMMD 100-S1	TMMD 100-A2	135	5.3	16	0.6	79	3.1	19 3/4"
	TMMD 100-A3	137	5.4	23	0.9	77	3.0	
TMMD 100-S2	TMMD 100-A4	162	6.4	26	1.0	52	2.0	24 15/16"
	TMMD 100-A5	167	6.6	52	2.0	49	1.9	
	TMMD 100-A6	170	6.7	100	3.9	49	1.9	

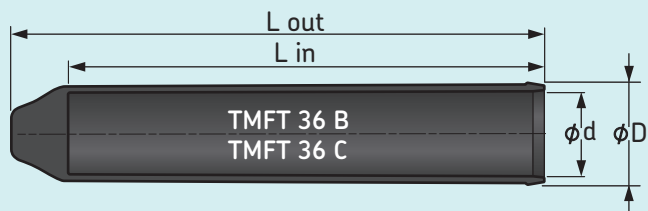

	d		D		L _{in}		L _{out}	
	mm	in	mm	in	mm	in	mm	in
TMFT 36 B	37	1.4	45	1.7	210	8.3	235	9.3
TMFT 36 C	57	2.2	66	2.6	215	8.4	245	9.6

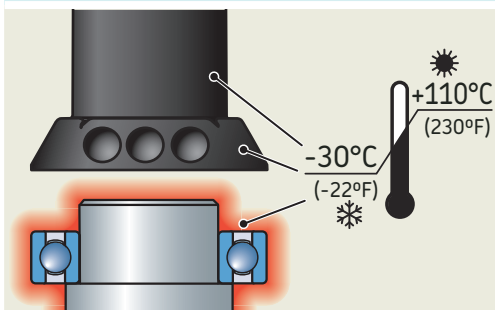
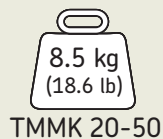

TDTC 1/C

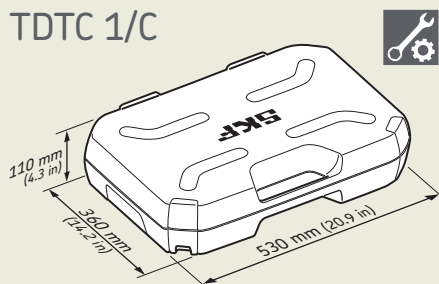

TMMX 210

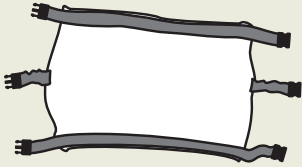

LGEV 2/0.035

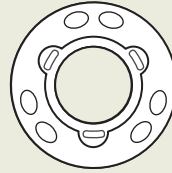

TMFT 36 B20-42 TMFT 36 B25-47
 TMFT 36 B20-47 TMFT 36 B25-52
 TMFT 36 B20-52 TMFT 36 B25-62
 TMFT 36 B30-55 TMFT 36 B35-62
 TMFT 36 B30-62 TMFT 36 B35-72
 TMFT 36 B30-72 TMFT 36 B35-80

TMFT 36-H

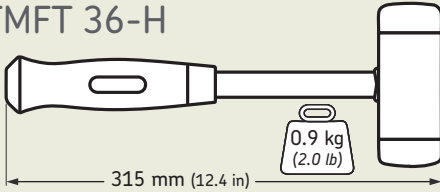

TMMD 100-A2

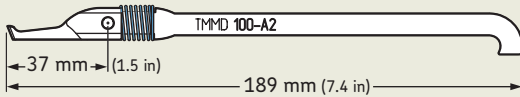

TMMD 100-A3

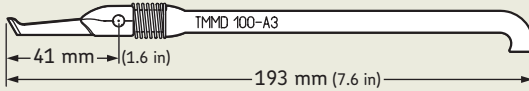

TMMD 100-A4

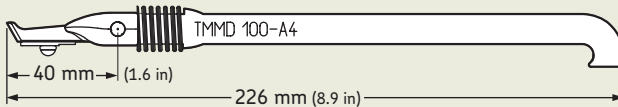

TMMD 100-A5

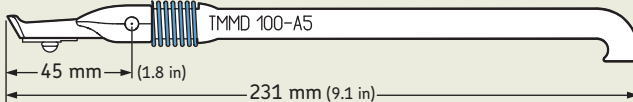

TMMD 100-A6

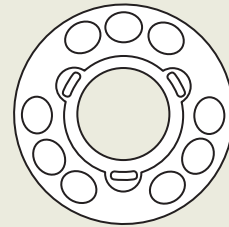
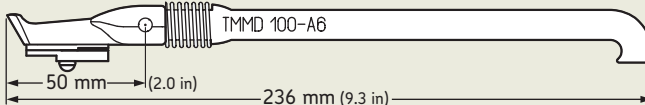

TMFT 36 C40-68 TMFT 36 C50-80
 TMFT 36 C40-80 TMFT 36 C50-90
 TMFT 36 C40-90 TMFT 36 C50-110
 TMFT 36 C45-75
 TMFT 36 C45-85
 TMFT 36 C45-100

TMIP S1

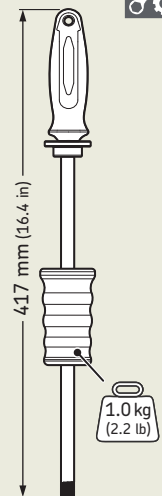

The contents of this publication are the copyright of the publisher and may not be reproduced (even extracts) unless prior written permission is granted. Every care has been taken to ensure the accuracy of the information contained in this publication but no liability can be accepted for any loss or damage whether direct, indirect or consequential arising out of the use of the information contained herein.

Nachdruck, auch auszugsweise, nur mit unserer vorherigen schriftlichen Genehmigung gestattet. Die Angaben in dieser Druckschrift wurden mit größter Sorgfalt auf ihre Richtigkeit hin überprüft. Trotzdem kann keine Haftung für Verluste oder Schäden irgendwelcher Art übernommen werden, die sich mittelbar oder unmittelbar aus der Verwendung der hier enthaltenen Informationen ergeben.

El contenido de esta publicación es propiedad de los editores y no puede reproducirse (incluso parcialmente) sin autorización previa por escrito. Se ha tenido el máximo cuidado para garantizar la exactitud de la información contenida en esta publicación, pero no se acepta ninguna responsabilidad por pérdidas o daños, ya sean directos, indirectos o consecuentes, que se produzcan como resultado del uso de dicha información.

Le contenu de cette publication est soumis au copyright de l'éditeur et sa reproduction, même partielle, est interdite sans autorisation écrite préalable. Le plus grand soin a été apporté à l'exactitude des informations données dans cette publication mais SKF décline toute responsabilité pour les pertes ou dommages directs ou indirects découlant de l'utilisation du contenu du présent document.

La riproduzione, anche parziale, del contenuto di questa pubblicazione è consentita soltanto previa autorizzazione scritta della SKF. Nella stesura è stata dedicata la massima attenzione al fine di assicurare l'accuratezza dei dati, tuttavia non si possono accettare responsabilità per eventuali errori od omissioni, nonché per danni o perdite diretti o indiretti derivanti dall'uso delle informazioni qui contenute.

O conteúdo desta publicação é de direito autoral do editor e não pode ser reproduzido (nem mesmo parcialmente), a não ser com permissão prévia por escrito. Todo cuidado foi tomado para assegurar a precisão das informações contidas nesta publicação, mas nenhuma responsabilidade pode ser aceita por qualquer perda ou dano, seja direto, indireto ou consequente como resultado do uso das informações aqui contidas.

Содержание этой публикации является собственностью издателя и не может быть воспроизведено (даже частично) без предварительного письменного разрешения. Несмотря на то, что были приняты все меры по обеспечению точности информации, содержащейся в настоящем издании, издатель не несёт ответственности за любой ущерб, прямой или косвенный, вытекающий из использования вышеуказанной информации.

本出版物内容的著作权归出版者所有且未经事先书面许可不得被复制(甚至引用)。我们已采取了一切注意措施以确定本出版物包含的信息准确无误,但我们不对因使用此等信息而产生的任何损失或损害承担任何责任,不论此等责任是直接、间接或附随性的。



skf.com • skf.com/mapro

© SKF is a registered trademark of the SKF Group.

© SKF Group 2024

MP5444 · 2024/09